

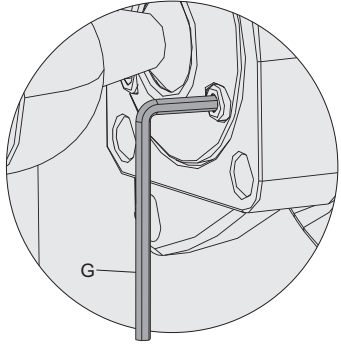

4. Adjustment

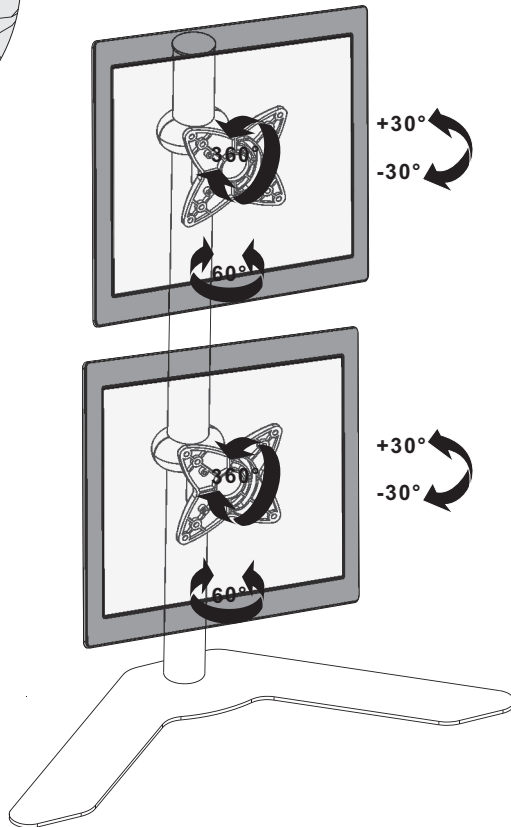

Depending on the weight of the display, it may be necessary to make adjustments to the Ball Joint Mechanism.



Adjust to desired location or tilt.

Maintenance

- Check that the bracket is secure and safe to use at regular intervals (at least every three months).
- Please contact your dealer if you have any questions.

MONOPRICE® INSTALLATION INSTRUCTIONS

Vertical Table Stand

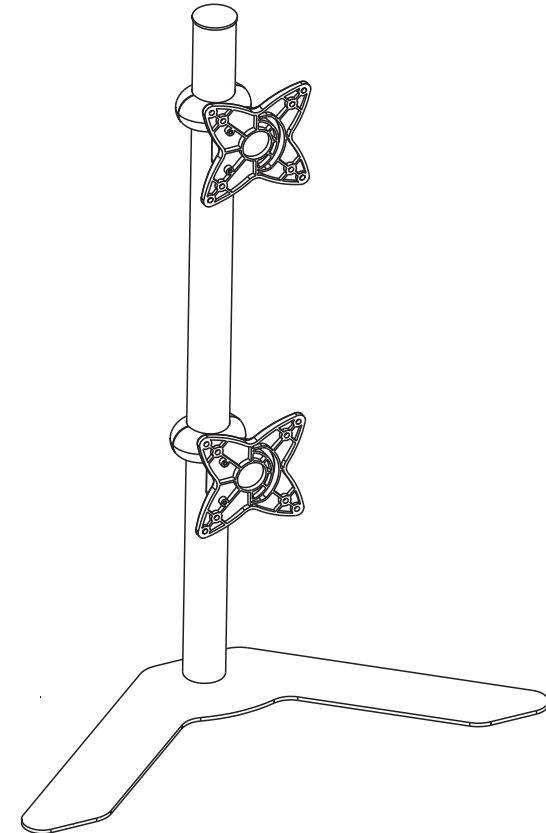

CAUTION: DO NOT EXCEED MAXIMUM LISTED WEIGHT CAPACITY. SERIOUS INJURY OR PROPERTY DAMAGE MAY OCCUR!

PID 5561



75x75
100x100



ISSUED: NOV. 2012

NOTE: Read the entire instruction manual before you start installation and assembly.

WARNING

- Do not begin the installation until you have read and understood the instructions and warnings contained in this installation sheet. If you have any question regarding any of the instruction or warning, please contact your local distributor.
- This mounting bracket was designed to be installed and utilized **ONLY** as specified in this manual. Improper installation of this product may cause damage or serious injury.
- Make sure that the supporting surface will safely support the combined load of the equipment and all attached hardware and components.
- Tighten screws firmly, but do not over tighten. Over tightening can damage the items, greatly reducing their holding power.
- This product is intended for indoor use only. Using this product outdoors could lead to product failure and personal injury.
- This product is a free standing. pole mount solution for multiple displays.

Component Checklist

IMPORTANT: Ensure that you have received all parts according to the component checklist prior to installing. If any parts are missing or faulty, telephone your local distributor for a replacement.

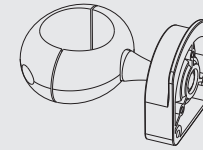

adapter bracket
assembly (x2)
A



pole (x1)
C

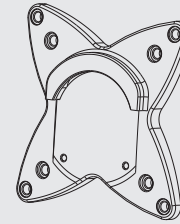

VESA plate (x2)
B

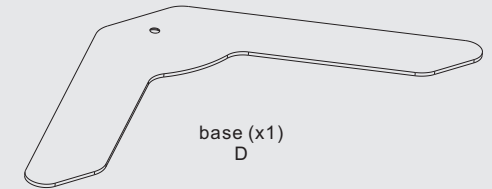

base (x1)
D



M10x20 (x1)
E

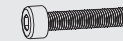

M5x20 (x4)
F



3mm Allen key (x1)
G



4mm Allen key (x1)
H

Package M x2

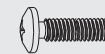

M4x14 (x4)
M-A

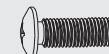

M5x14 (x4)
M-B

1. Assemble the Table Stand

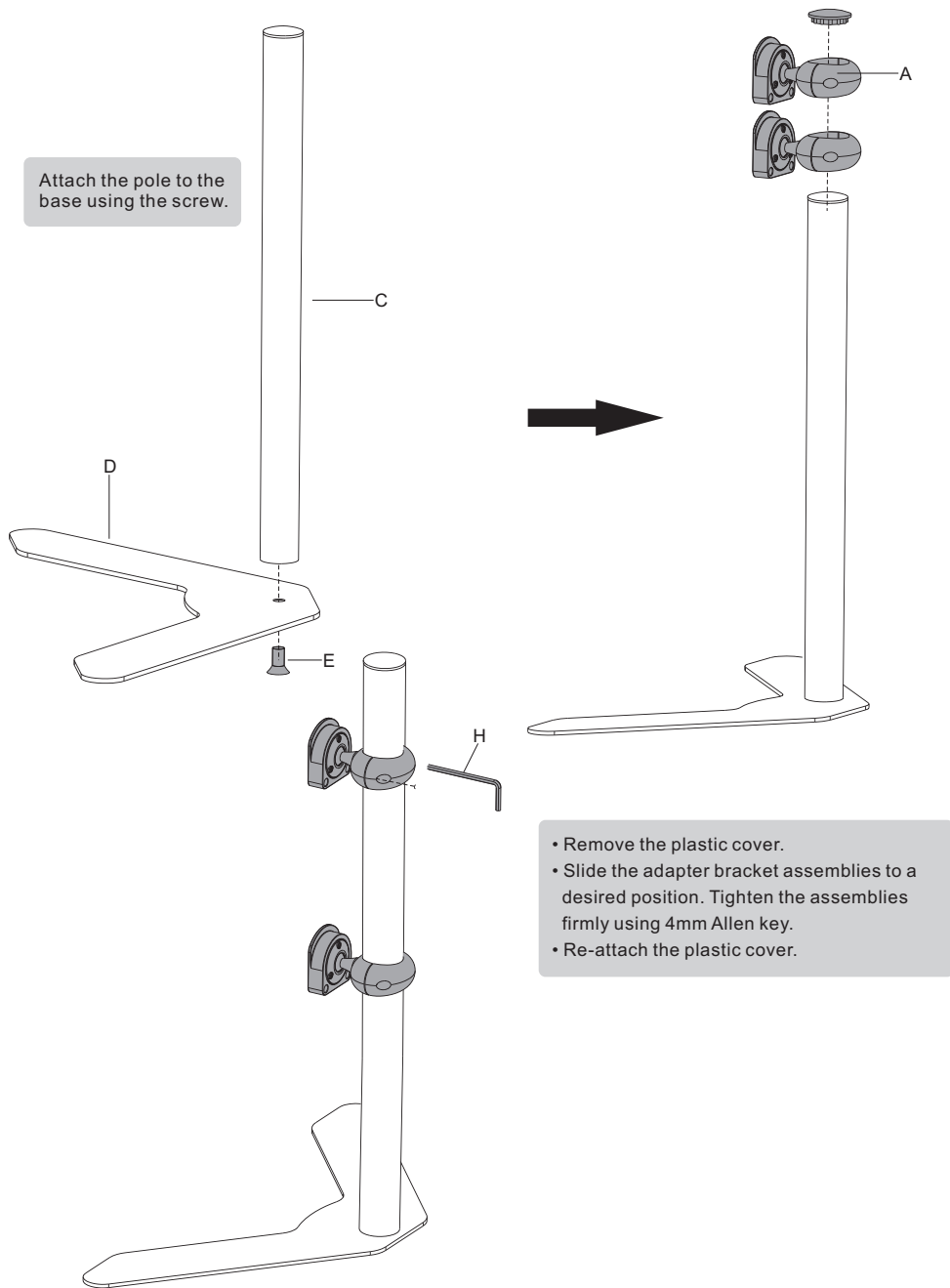

2. Install the VESA Plates

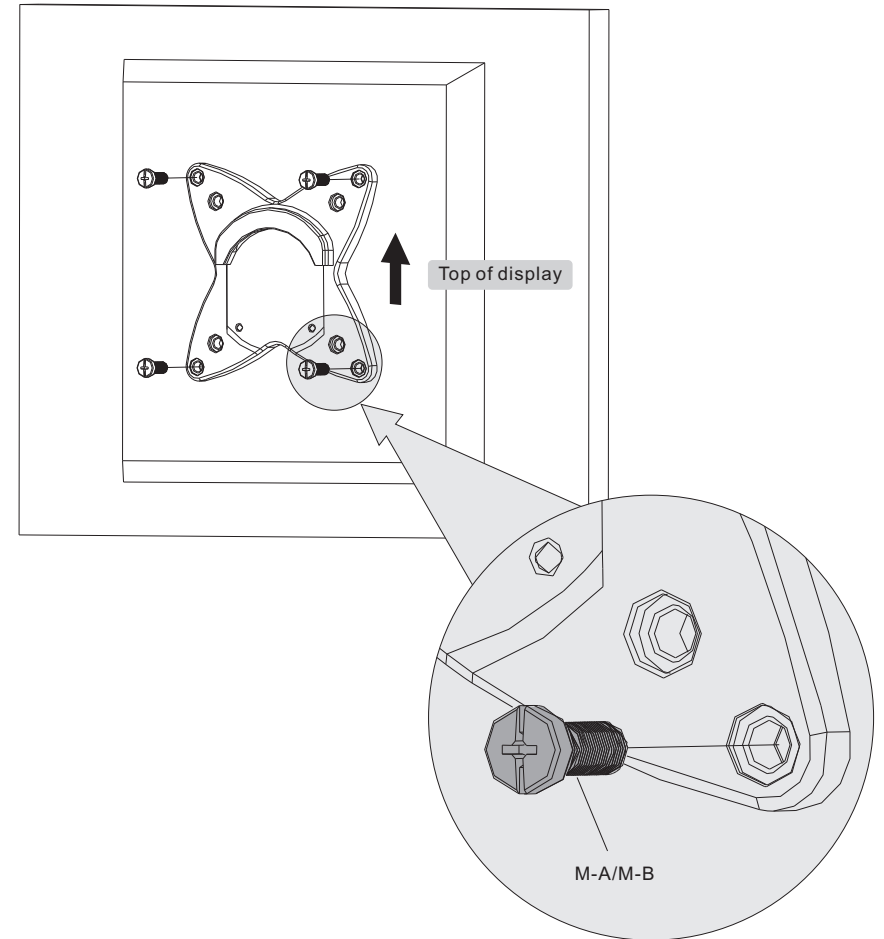

Screw the VESA plate onto the display.
⚠ Tighten all screws but do not over tighten.

3. Install the Displays

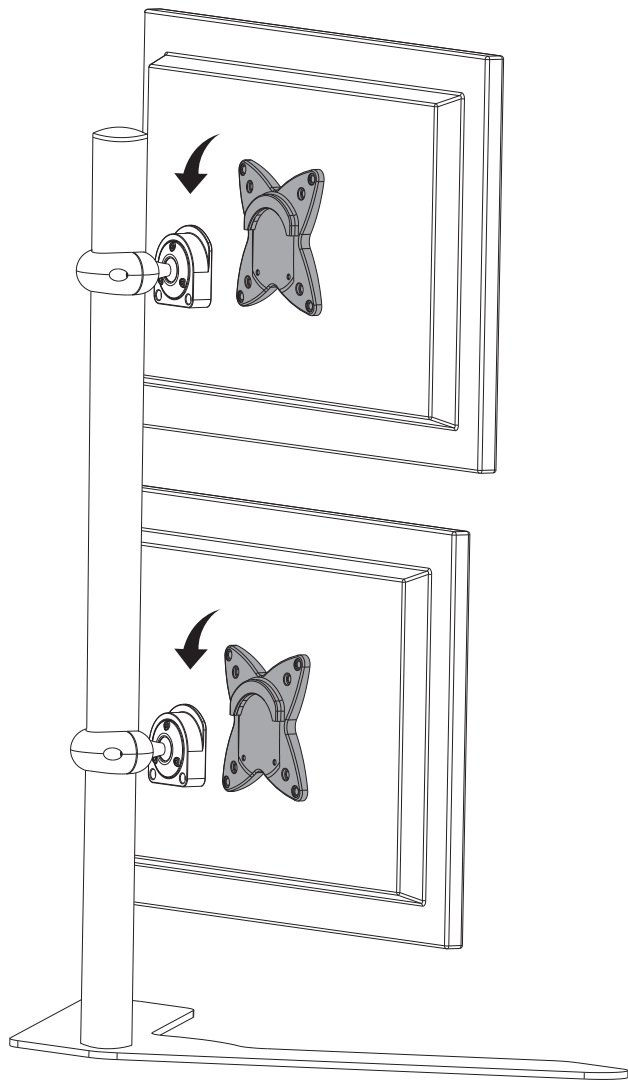

Lift your display carefully and hook the VESA plate onto the mounted head.

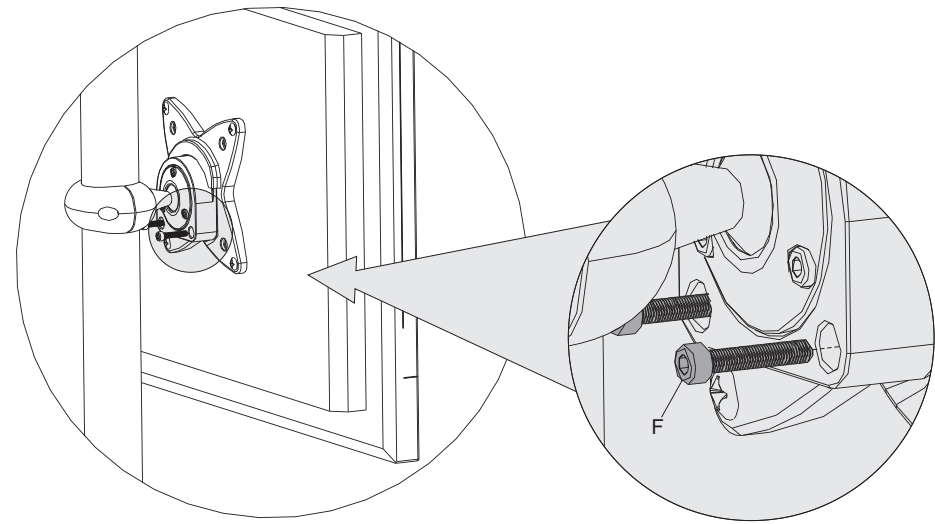

Insert two screws into mounting holes for each adapter bracket.

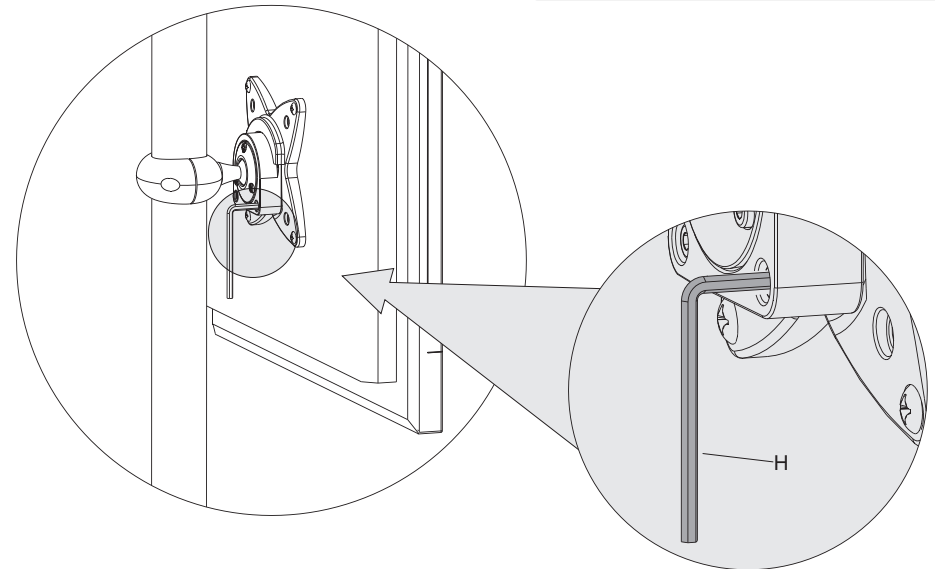

Tighten all screws using 4mm Allen key.